



Product Specification

Ningbo East Electronics Limited
NO. 88 East Jinhui Road, Yinzhou Ningbo 315100, P.R.China
<http://www.east-mingtao.com>

Product Name:	SMD External -Driven Piezo Transducer
Part Number:	SFM-1240-03
Version:	1.03
Date:	2015-5-30
Note:	

Company passed ISO 9001 / ISO TS16949 / ISO 14001 Certifications

Revision History

Rev.	Description	Author/Date	Checked By	Approver
1.03	change the paper reel to plastic reel	刘进 2015-5-30	汤礼东	王建成
1.02	Quality Certificate Symbol revised	刘宁 2015-2-4	汤礼东	王建成
1.01	Cancel the mark point	陈启旺 2014-6-30	吴磊	王建成

1. Part Number SFM-1240-03

2. Dimension Drawing (Unit: mm)

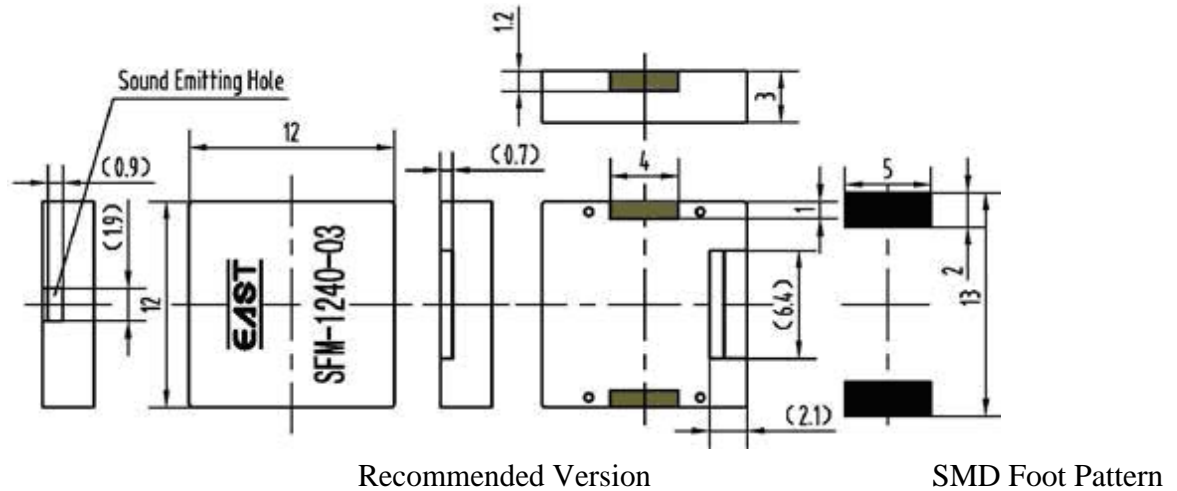

Recommended Version

SMD Foot Pattern

Solder paste thickness is not below 0.2mm

3. Specification

No.	Item	Specification
3-1	Min. Sound Pressure Level	76dB/4.0KHz/3Vp-p Square Wave/10cm
3-2	Capacitance at 1000Hz	15nF \pm 25%
3-3	Allowable Input Voltage	30Vp-p
3-4	Max. Consumption	3mA/4.0kHz/3Vp-p square wave
3-5	Resonant Frequency	4.0 \pm 0.5KHz
3-6	Operating Temperature	-40~+120°C
3-7	Operating Temperature	-40~+120°C
3-8	Case Material /Color	LCP/Black
3-9	Pin Material /Plated	Cu/Sn
3-10	Weight	0.5g

NOTES:

Test should be made under the conditions of room temperature (20 \pm 10°C), normal humidity (60 \pm 20%) and normal atmospheric pressure. In this case, however, that the judgment is questionable, the test conditions are to be changed to room temperature 20 \pm 2°C, relative humidity 60~70% and normal atmospheric pressure

4. Typical Frequency Response Curve

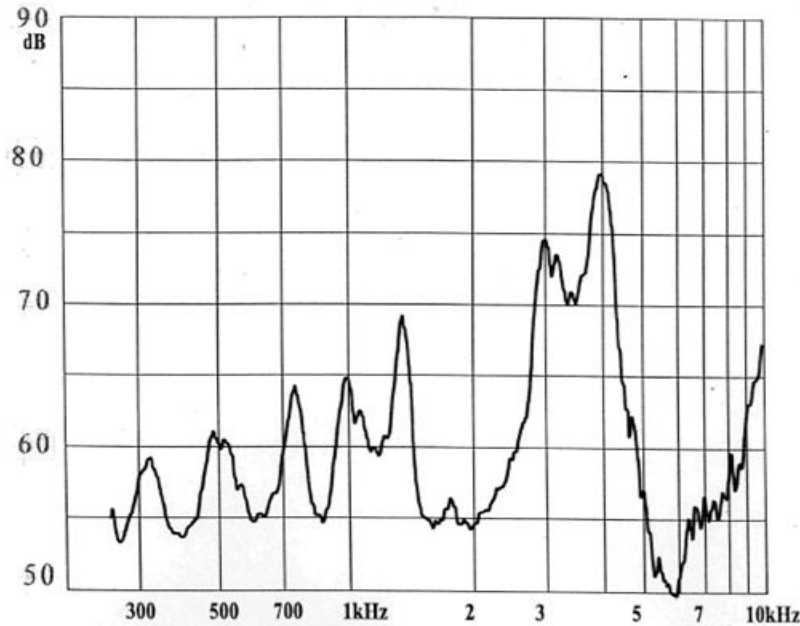

Note: Input Voltage 3Vp-p Square Wave
Distance 10 cm

5. Reliability Test

No.	Item	Method of Test	Tolerance after Testing
5-1	Operating Temperature	-40~+120°C	Sound pressure level initial value ± 10 dB Max. consumption value $\pm 20\%$ Capacitance value $\pm 20\%$
5-2	Storage in high temperature	Storage in +120°C test box 96 hours then exposed to the room temperature for 2 hours	
5-3	Storage in low temperature	Storage in -40°C test box 96 hours then exposed to the room temperature for 2 hours	
5-4	Life test in the room temperature	Operate the product continuously 5 seconds on 5 seconds off 300 hours at rated voltage	
5-5	Temperature / humidity cycle test	Storage in +40°C, 93 \pm 3%RH test box 96 hours then exposed to the room temperature for 2 hours	
5-6	Temperature (high and low) cycle test	Conduct the test for 5 cycles without applying power then expose to the room temperature for 2 hours.(See Figure 5-6)	
5-7	Vibration test	Conduct the test for the directions of X Y and Z for 0.5 hour each (total 1.5 hours). To-and Fri sweep time(from 10 to 55Hz and then 55 to 10) under single amplitude of 0.75mm is 3 minute, then expose to the room temperature for 2 hours	

5-8	Drop test	Drop a product naturally from the height of 700mm onto the surface of 100mm thick wooden board. Two directions: upper and side of the product are to be applied for this drop test once respectively	
5-9	Reflow soldering heat resistance	a) Pre-heating conditions shall be +140°C to 160°C for 160 to 200 seconds. (See Figure5-9) b) Heating conditions shall be within 60 seconds at +200°C min., but peak temperature shall be lower than +260°C. (See Figure 5-9)	
5-10	Test of soldering	Dip the connecting pins in soldering at 230±5°C for 3±0.5 seconds	Solder shall be attached around over 95% of the dipped portion

NOTE: The pins are allowed to deform after drop test.

Figure 5-6

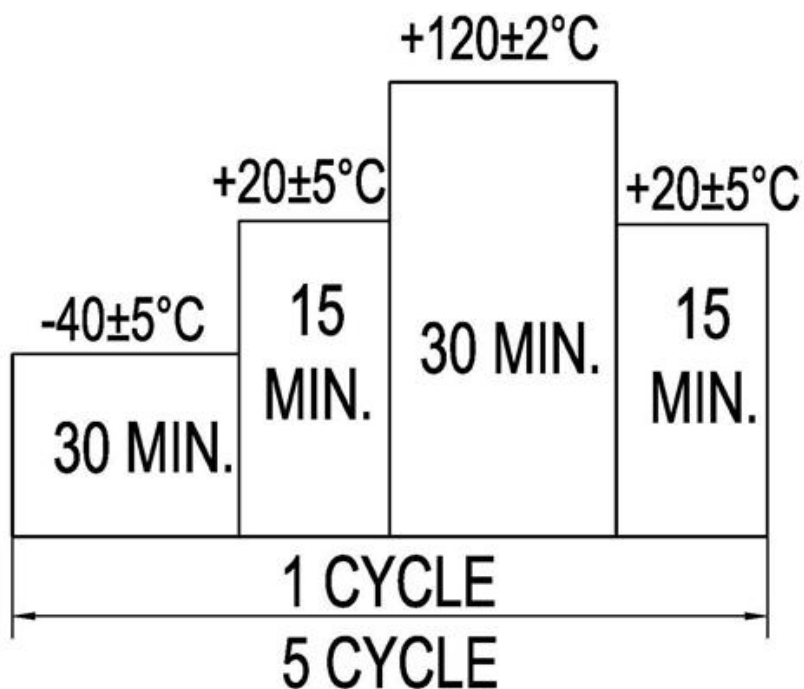
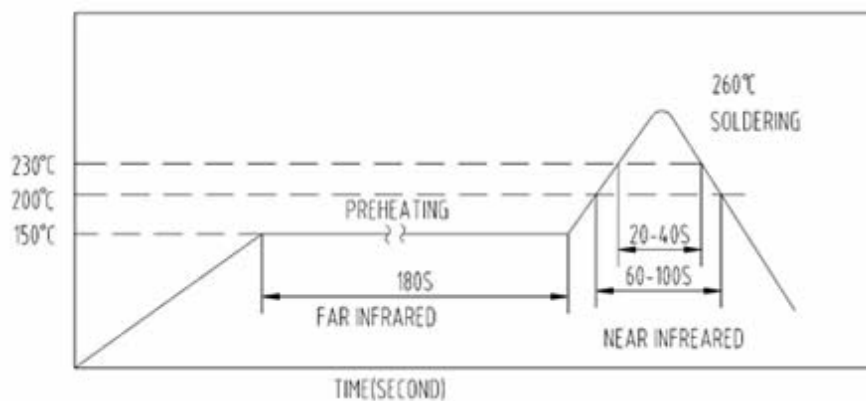
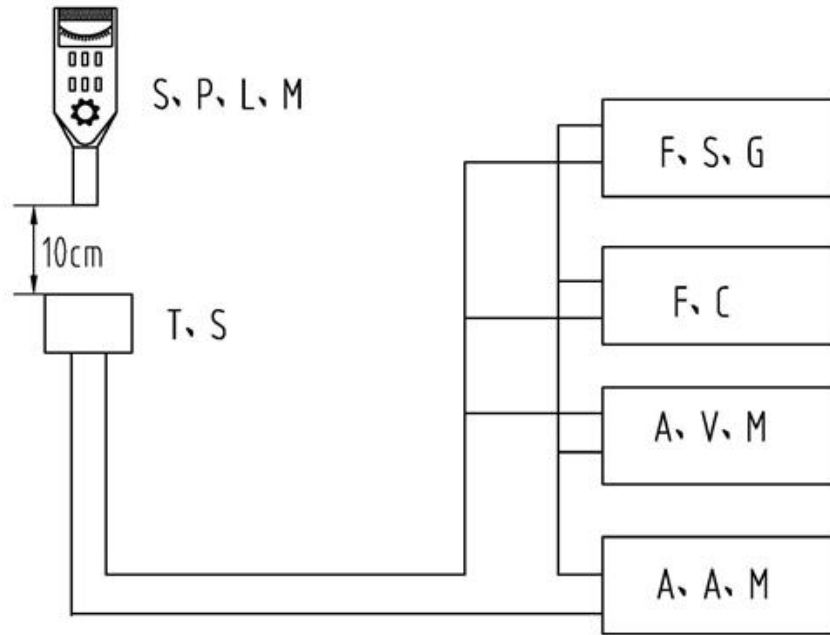

Figure 5-9



6. Electrical Testing Method



S.P.L.M	Sound Pressure Level Meter
T.S	Testing Sample
T.C	Test Circuit
F.C	Frequency Counter
F.S.G	Frequency Signal Generator
A.V.M	AC Voltage Meter
A.A.M	AC Ampere Meter

TC:

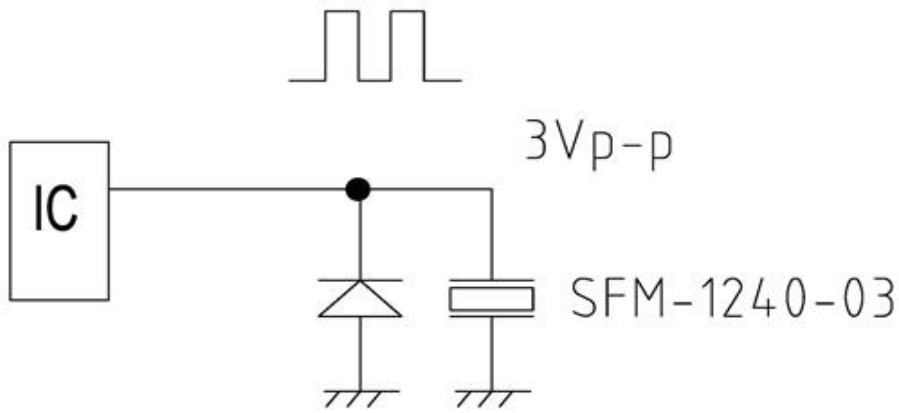

7. Packing Information

No.	Item	Description
7-1	Tape type information	<p>a) The design for such tape packing was executed under standard IEC - 286-3</p> <p>b) The material of the tape is polystyrene in black color. Detailed dimensions are as below: (See Figure7-1)</p>
7-2	Dimensions of the rolling plate	<p>a) The material of the rolling plate is plastic.</p> <p>b) The dimensions of the rolling plate are as below(See Figure7-2)</p>
7-3	Packing dimensions and quantity	<p>a) The rolling plate is put into a 340X335X35mm inner packing box and is packed with 1000pcs of transducer per plate.</p> <p>b) The dimension of the outer carton is 400X 350X 350mm containing 10 inner boxes with a total quantity of 10000 pcs of transducer.</p> <p>c) The total gross weight per carton is 11.6Kgs, while net weight is 5.0Kgs.</p>

Figure 7-1

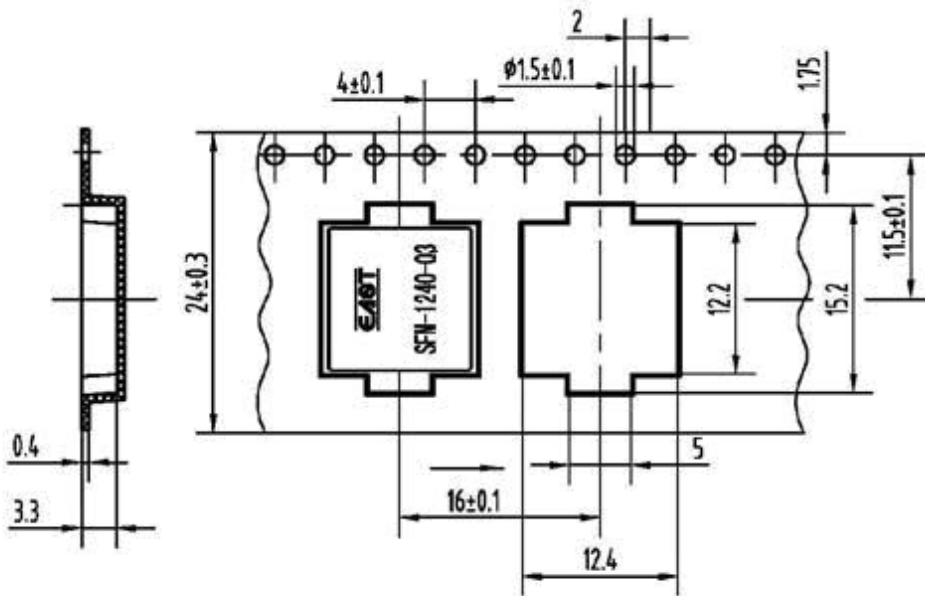

Figure 7-2

